

# GROVE®

## TMS745E



TRUCK MOUNTED  
HYDRAULIC CRANE

# Dimensions

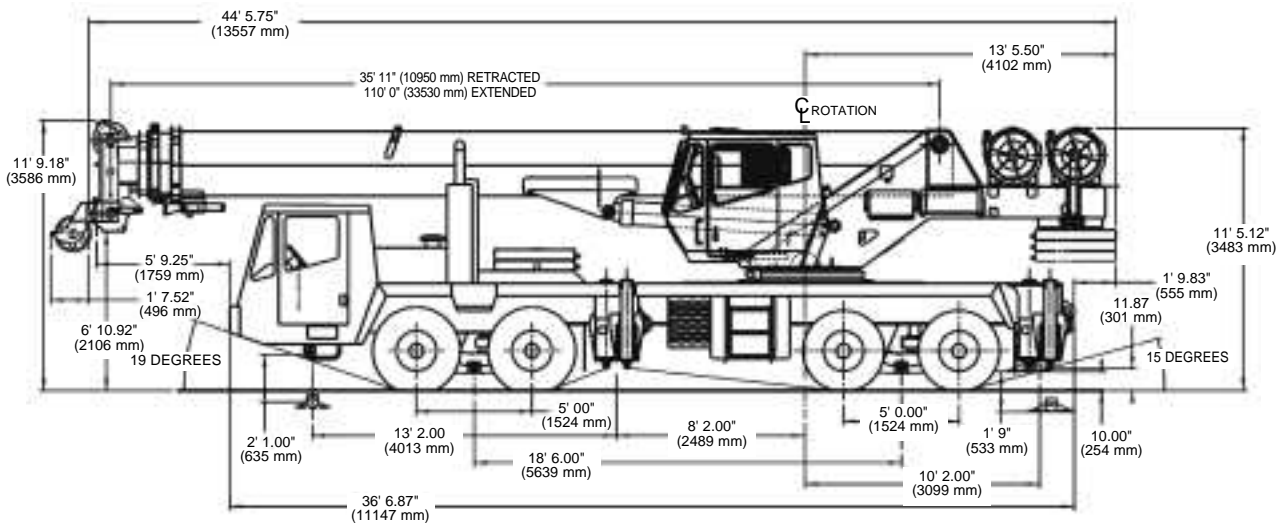
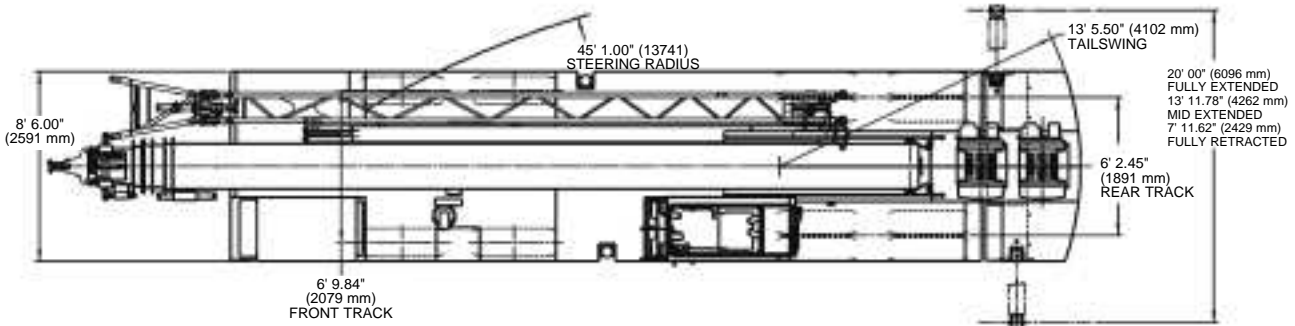

# Working Range



36 - 110 ft.  
(11 - 33.5 m)



33 ft or 56 ft  
(10.1 m or 17.1 m)



16,500 lbs  
(7 484 Kg)

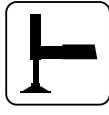

100%



360°

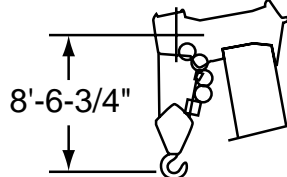
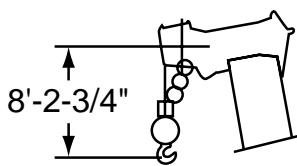
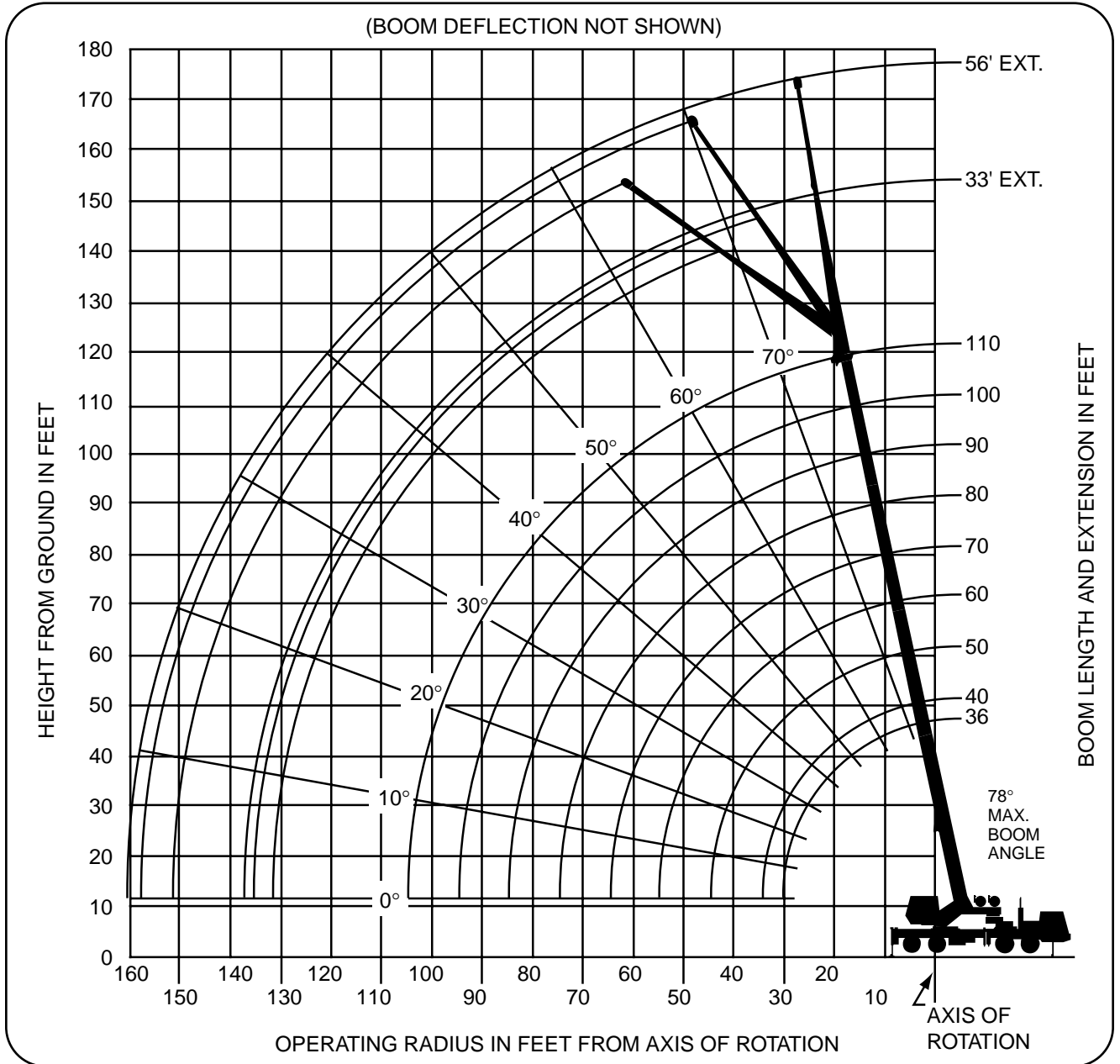

DIMENSIONS ARE FOR LARGEST GROVE FURNISHED HOOK BLOCK AND HEADACHE BALL, WITH ANTI-TWO BLOCK ACTIVATED.

# Superstructure Specifications

## Boom

36 ft. - 110 ft. (11 m - 33.5 m) four section full power sequenced synchronized boom.

Maximum Tip Height: 118 ft. (35.9 m).

## Folding Lattice Extension

33 ft. or 56 ft. (10.1 m or 17.1 m) folding lattice swingaway extension offsettable at 0°, 25° or 45°. Stows alongside base boom section.

Maximum Tip Height: 172.5 ft. (52.6 m).

## \*Optional Lattice Extension

33 ft. (10.1 m) lattice swingaway extension, offsettable at 0°, 25° or 45°. Stows alongside base boom section.

Maximum Tip Height: 148 ft. (45.1 m).

## \*Optional 20 ft. (6.1 m) or 40 ft. (12.2 m)

### Swingaway Extension Inserts

Installs between boom nose and extension, non-stowable.

Maximum Tip Height: 192 ft. (58.5 m) - 20 ft. insert.  
212 ft. (64.6 m) - 40 ft. insert.

## Boom Nose

Quick reeving type boom nose with 3 nylatron sheaves (4 for 60 ton rating) mounted on heavy duty tapered roller bearings with removable pin-type rope guards, (4 and 5 sheaves respectively with optional 18 x19 wire rope). Removable auxiliary boom nose with removable pin type rope guard.

## Boom Elevation

One double acting hydraulic cylinder with integral holding valve provides elevation from -3° to 78°.

## Load Moment

### & Anti-Two Block System

Standard "Graphic Display" load moment and anti-two block system with audio-visual warning and control lever lockout. These systems provide electronic display of boom angle, length, radius, tip height, relative load moment, maximum permissible load, load indication and warning of impending two-block condition. The standard "**Work Area Definition System**" allows the operator to pre-select and define safe working areas. If the crane approaches the pre-set limits, audio-visual warnings aid the operator in avoiding job-site obstructions.

## Cab

High visibility, all steel cab with acoustical lining and tinted safety glass throughout. Deluxe seat with armrest mounted hydraulic single axis controls. Dash panel incorporates gauges for all engine functions. Other standard features include: sliding side and rear windows, hot water heat, electric windshield wash/wipe, circulating air fan, sliding skylight with sunscreen and electric skylight wiper, fire extinguisher, cup holder.

## Swing

Planetary swing with foot applied multi-disc wet brake. Spring applied, hydraulically released parking brake. Two position plunger type and 360° mechanical house locks operated from cab.

Maximum speed: 2.5 RPM.

## Counterweight

11,000 lb. (4 990 kg), consisting of (2) 5,500 lb. (2 495 kg) sections.

\*Optional "Heavy Lift" package consisting of (1) additional 5,500 lb. (2 495 kg) section, for a total of 16,500 lb. (7 484 kg). Hydraulic installation/removal.

## Hydraulic System

Two main gear pumps with a combined capacity of 135.4 GPM (513 L/m). Two individual post pressure compensated valve banks. Maximum operating pressure: 4000 psi (27.6 Mpa).

Return line type filter with full flow by-pass protection and service indicator. Replaceable cartridge with beta rating of 5/12/16.

170 gallons (643 L) reservoir. Remote mounted oil cooler with thermostatically controlled electric motor driven fan.

## Hoist Specifications

### Main and Auxiliary Hoists-Model

#### HO3OG-16G

Planetary reduction with integral automatic brake, electronic hoist drum rotation indicator, and hoist drum cable follower. Grooved drum.

Maximum Single Line Pull:	18,134 lb. (8226 kg)
Maximum Single Line Speed:	580 FPM (177 m/min)
Maximum Permissible Line Pull:	16,800 lb. (7620 kg) w/standard 6 x 37 class rope
	12,920 lb. (5879 kg) w/optional 18 x 19 class rope
Rope Diameter:	3/4 in. (19 mm)
Rope Length:	500 ft. (152 m)
Rope Type:	6 x36 WS non-rotation resistant Optional 18 x19 rotation resistant
Maximum Rope Stowage:	695 ft. (212m)

*\*Denotes optional equipment*

# Carrier Specifications

## Chassis

Triple box section, four-axle carrier fabricated from high-strength, low alloy steel with towing and tie-down lugs.

## Outrigger System

Four hydraulic telescoping, single-stage, double box beam outriggers with inverted jack and integral holding valves. Quick release type steel outrigger floats 24 in. (610 mm) diameter. Three position setting with fully extended, intermediate (50%) extended and fully retracted capacities.

## Outrigger Controls

Located in the superstructure cab on left side (umbilical design), requires two hand operation. Crane level indicator (sight bubble) on right side console. \*Optional controls in lighted boxes, mounted on both sides of chassis.

## Engine

Cummins ISM 400 diesel, six cylinders, turbo-charged, after cooled, 661 cu. in. (10.8 L), 400 bhp (298 kW) (gross) @ 1500 RPM. Maximum torque: 1,450 ft. lb. (1966 Nm) @ 1200 RPM. Equipped with engine brake, engine block heater, cold start aid (less canister) and audio-visual engine distress system.

## Fuel Tank Capacity

100 gallons (376 L)

## Transmission

Roadranger 10 speeds forward, 3 reverse.

## Drive

8 x 4 x 4.

## Steering

Front axle, single circuit, mechanical steering with hydraulic power assist.

## Axles

Front: (2) Eaton beam-type steering axles, 83.3 in. (2.1 m) track.  
Rear: (2) Meritor single reduction drive axles, 75.1 in. (1.9 m) track.  
Inter-axle differential locks.

## Brakes

Dual air, split-system operating on all wheels. S-cam brakes on the front and wedge brakes on the rear. Spring-applied, air released parking brake acting on rear axles. Air dryer.

## Suspension

Front: Walking beam with air bags and shock absorbers.  
Rear: Walking beam with air bags and shock absorbers.

## Tires

Front: 445/65R 22.5 Goodyear G286, tubeless, mounted on aluminum disc wheels.  
Rear: 315/80R 22.5 Goodyear G286, tubeless, mounted on aluminum disc wheels.

## \*Optional Tires

Front: 445/65R 22.5 Bridgestone M844F, tubeless.  
445/65R 22.5 Michelin XZY (WB), tubeless.  
Rear: 315/80R 22.5 Bridgestone M843, tubeless.  
315/80R 22.5 Michelin XZY-1 tubeless.

## Lights

Full lighting package including turn indicators, head, tail, brake, and hazard warning lights.

## Cab

One man design, all steel fabricated with acoustical lining and tinted safety glass throughout. Deluxe fabric covered, fully adjustable air ride seat. Complete driving controls and engine instrumentation including tilt telescope steering wheel, tachometer, speedometer, voltmeter, water temp., oil pressure, fuel level, air pressure gauge with A/V warning and engine high temp./low oil pressure A/V warning. Other standard items include hot water heater/defroster, electric windshield wash/wipe, fire extinguisher, seat belt, door lock and electric window.

## Electrical System

Two 12 V - 2150 CCA maintenance free batteries. 12 V lighting/starting. Battery disconnect standard equipment.

## Maximum Speed

65 MPH (104 kph)

## Gradeability (Theoretical)

70%

## Gross Vehicle Weight

STANDARD MACHINE.

87,429 lb. (39 658 kg), Bi-fold extension, 2 hoists with cable, hookblock, headache ball and 11,000 lb. (4990 kg) counterweight

## Miscellaneous Standard Equipment

Aluminum fenders with rear storage compartments; dual rear view mirrors; electronic back-up alarm; pump disconnect; tire inflation kit; air cleaner restriction indicator; block and ball stowage; and chrome package which includes aluminum wheels.

## Optional Equipment

- \* Flashing Light Package - Includes amber strobe for both cabs
- \* Trailing Boom Package - Includes trailer air and electrical disconnects and trailing boom kit with no spin differential (less dolly)
- \* Hookblocks
- \* Air conditioning
- \* Rear pintle hook
- \* Aluminum outrigger pads
- \* Cross axle differential locks
- \* LMI calibration for on-rubber over the rear
- \* LMI light bar
- \* LMI data logger
- \* Air horn

*\*Denotes optional equipment*

**RATED LIFTING CAPACITIES IN POUNDS  
WITH 16,500 LB. REMOVABLE COUNTERWEIGHT  
36 FT. - 110 FT. BOOM**

**ON OUTRIGGERS FULLY EXTENDED - 360°**

Radius in Feet	#0001								
	Main Boom Length in Feet								
	36	40	50	**60	70	80	90	100	110
10	90,000 (69)	84,400 (72)	80,200 (76)	*62,500 (78)					
12	90,000 (65.5)	84,400 (68.5)	80,200 (73.5)	62,500 (77)	*36,800 (78)				
15	87,300 (59.5)	82,700 (63.5)	80,200 (70)	61,000 (74)	36,800 (76.5)	*36,800 (78)	*31,000 (78)		
20	68,250 (49)	65,000 (55)	64,300 (63.5)	50,650 (69)	36,800 (72)	36,800 (75)	31,000 (77)	*29,100 (78)	*24,000 (78)
25	54,900 (36)	53,100 (45)	52,000 (56.5)	41,800 (63.5)	36,800 (68)	34,000 (71)	30,000 (73.5)	27,000 (76)	24,000 (77.5)
30		39,350 (31.5)	38,700 (48.5)	37,850 (57.5)	33,400 (63)	29,000 (67)	25,300 (70.5)	24,200 (72.5)	22,000 (75)
35			29,400 (40)	28,400 (51.5)	28,700 (58)	25,000 (63)	22,200 (67)	21,750 (69.5)	20,000 (72)
40	See Note 16		23,050 (28)	22,100 (45)	22,750 (53)	22,000 (59)	20,200 (63)	19,000 (66.5)	18,500 (69)
45				17,550 (37)	18,250 (47.5)	18,800 (54.5)	17,800 (59.5)	17,300 (63)	17,300 (66.5)
50				14,050 (26.5)	14,850 (41)	15,600 (49.5)	16,000 (55.5)	16,000 (60)	16,000 (63.5)
55					12,200 (33.5)	12,950 (44.5)	13,650 (51)	14,100 (56.5)	14,100 (60)
60					10,050 (24)	10,850 (38.5)	11,600 (47)	12,000 (52.5)	12,200 (57)
65						9,110 (31.5)	9,900 (42)	10,250 (48.5)	10,600 (53.5)
70						7,650 (22.5)	8,450 (36.5)	8,820 (44.5)	9,000 (50)
75							7,210 (30)	7,580 (40)	7,800 (46.5)
80							6,150 (21.5)	6,490 (34.5)	6,600 (42.5)
85								5,550 (28.5)	5,800 (38)
90								4,730 (20.5)	5,000 (33)
95									4,270 (27.5)
100									3,600 (19.5)
Minimum boom angle (deg.) for indicated length (no load)								0	
Maximum boom length (ft.) at 0 degree boom angle (no load)								1	10

NOTE: ( ) Boom angles are in degrees.

#LMI operating code. Refer to LMI manual for instructions.

\*This capacity is based on maximum boom angle.

Lifting Capacities at Zero Degree Boom Angle									
Boom Angle	Main Boom Length in Feet								
	36	40	50	**60	70	80	90	100	110
0°	29,050 (29.8)	24,450 (34.2)	17,050 (44.2)	11,600 (54.6)	8,570 (64.2)	6,610 (74.2)	5,380 (84.2)	4,120 (94.2)	3,110 (104.2)

NOTE: ( ) Reference radii in feet.

A6-829-101844

\*\*60 ft. boom length is with inner-mid extended and outer-mid & fly retracted.

THIS CHART IS ONLY A GUIDE AND SHOULD NOT BE USED TO OPERATE THE CRANE. The individual crane's load chart, operating instructions and other instructional plates must be read and understood prior to operating the crane.

**RATED LIFTING CAPACITIES IN POUNDS  
WITH 16,500 LB. REMOVABLE COUNTERWEIGHT  
36 FT. - 110 FT. BOOM**

**ON OUTRIGGERS FULLY EXTENDED - OVER REAR**

Radius in Feet	#0001								
	Main Boom Length in Feet								
	36	40	50	**60	70	80	90	100	110
10	90,000 (69)	84,400 (72)	80,200 (76)	*62,500 (78)					
12	90,000 (65.5)	84,400 (68.5)	80,200 (73.5)	62,500 (77)	*36,800 (78)				
15	87,300 (59.5)	82,700 (63.5)	80,200 (70)	61,000 (74)	36,800 (76.5)	*36,800 (78)	*31,000 (78)		
20	68,250 (49)	65,000 (55)	64,300 (63.5)	50,650 (69)	36,800 (72)	36,800 (75)	31,000 (77)	*29,100 (78)	*24,000 (78)
25	55,650 (36)	53,100 (45)	52,000 (56.5)	41,800 (63.5)	36,800 (68)	34,000 (71)	30,000 (73.5)	27,000 (76)	24,000 (77.5)
30		44,100 (31.5)	39,600 (48.5)	38,000 (57.5)	33,400 (63)	29,000 (67)	25,300 (70.5)	24,200 (72.5)	22,000 (75)
35			32,400 (40)	29,750 (51.5)	28,700 (58)	25,000 (63)	22,200 (67)	21,750 (69.5)	20,000 (72)
40	See Note 16		26,050 (28)	25,500 (45)	23,600 (53)	22,000 (59)	20,200 (63)	19,000 (66.5)	18,500 (69)
45				20,000 (37)	19,700 (47.5)	18,800 (54.5)	17,800 (59.5)	17,300 (63)	17,300 (66.5)
50				17,850 (26.5)	16,800 (41)	16,500 (49.5)	16,000 (55.5)	16,000 (60)	16,000 (63.5)
55					14,900 (33.5)	14,650 (44.5)	14,100 (51)	14,100 (56.5)	14,100 (60)
60					13,050 (24)	12,800 (38.5)	12,200 (47)	12,200 (52.5)	12,200 (57)
65						11,450 (31.5)	10,800 (42)	10,600 (48.5)	10,600 (53.5)
70						10,100 (22.5)	9,450 (36.5)	9,000 (44.5)	9,000 (50)
75							8,290 (30)	7,800 (40)	7,800 (46.5)
80							7,140 (21.5)	6,600 (34.5)	6,600 (42.5)
85								5,800 (28.5)	5,800 (38)
90								5,000 (20.5)	5,000 (33)
95									4,440 (27.5)
100									3,880 (19.5)
Minimum boom angle (deg.) for indicated length (no load)								0	
Maximum boom length (ft.) at 0 degree boom angle (no load)								1	10

NOTE: ( ) Boom angles are in degrees.

#LMI operating code. Refer to LMI manual for instructions.

\*This capacity is based on maximum boom angle.

Lifting Capacities at Zero Degree Boom Angle									
Boom Angle	Main Boom Length in Feet								
	36	40	50	**60	70	80	90	100	110
0°	29,050 (29.8)	24,450 (34.2)	17,050 (44.2)	11,950 (54.6)	9,640 (64.2)	7,810 (74.2)	6,390 (84.2)	4,770 (94.2)	3,350 (104.2)

NOTE: ( ) Reference radii in feet.

A6-829-101845

\*\*60 ft. boom length is with inner-mid extended and outer-mid & fly retracted.

THIS CHART IS ONLY A GUIDE AND SHOULD NOT BE USED TO OPERATE THE CRANE. The individual crane's load chart, operating instructions and other instructional plates must be read and understood prior to operating the crane.

# 33 FT. - 56 FT. FOLDING OFFSETTABLE BOOM EXTENSION WITH 16,500 LB. REMOVABLE COUNTERWEIGHT

## ON OUTRIGGERS FULLY EXTENDED - 360°

Radius in Feet	33 ft. LENGTH			56 ft. LENGTH		
	#0021	#0022	#0023	#0041	#0042	#0043
	0° OFFSET	25° OFFSET	45° OFFSET	0° OFFSET	25° OFFSET	45° OFFSET
30	12,900 (78)					
35	12,900 (76)			*8,330 (78)		
40	12,900 (74)	*10,850 (78)		8,330 (77.5)		
45	12,900 (72)	10,450 (77)	*7,410 (78)	8,330 (76)		
50	12,100 (70)	10,000 (74.5)	7,200 (77.5)	8,330 (74.5)		
55	11,100 (68)	9,220 (72.5)	6,990 (75)	8,250 (73)	*5,300 (78)	
60	10,100 (66)	8,550 (70.5)	6,800 (72.5)	7,540 (71)	5,140 (77)	
65	9,130 (63.5)	7,930 (68)	6,650 (70.5)	7,160 (69)	5,100 (75)	*3,860 (78)
70	8,460 (61.5)	7,380 (65.5)	6,490 (68)	6,820 (67.5)	5,100 (73)	3,790 (77.5)
75	7,840 (59)	6,900 (63)	6,370 (65.5)	6,300 (65.5)	4,800 (71)	3,660 (75)
80	7,230 (56.5)	6,470 (60.5)	6,110 (62.5)	5,810 (63.5)	4,580 (69)	3,550 (73)
85	6,470 (54)	6,070 (58)	5,780 (60)	5,370 (61.5)	4,470 (67.5)	3,450 (71)
90	5,670 (51)	5,720 (55.5)	5,480 (57)	4,980 (59.5)	4,330 (65.5)	3,410 (68.5)
95	4,970 (48.5)	5,400 (52.5)	5,200 (54)	4,630 (57)	4,070 (63)	3,300 (66.5)
100	4,350 (45.5)	4,840 (49.5)	4,950 (51)	4,320 (55)	3,830 (61)	3,260 (64)
105	3,790 (42.5)	4,210 (46.5)	4,470 (47.5)	4,040 (52.5)	3,620 (58.5)	3,220 (62)
110	3,290 (39.5)	3,640 (43)		3,760 (50.5)	3,410 (56)	3,180 (59.5)
115	2,830 (36)	3,130 (39.5)		3,290 (48)	3,230 (53.5)	3,060 (56.5)
120	2,420 (32)	2,660 (35)		2,860 (45.5)	3,050 (51)	2,940 (53.5)
125	2,040 (27.5)	2,240 (30.5)		2,470 (42.5)	2,890 (48.5)	2,800 (50.5)
130	1,700 (22)			2,120 (39.5)	2,590 (45.5)	
135				1,790 (36.5)	2,200 (42.5)	
140				1,480 (33)	1,840 (38.5)	
145				1,200 (29.5)	1,500 (34.5)	
<b>No Load Stability Data</b>						
Min. boom angle for indicated length	21°	25°	45°	28°	28°	45°
Max. boom length at 0° boom angle	100 ft.			90 ft.		

- All capacities above the bold line are based on structural strength of boom extension.
- 33 ft. and 56 ft. boom extension lengths may be used for single line lifting service.
- Radii listed are for a fully extended boom with the boom extension erected. For main boom lengths less than fully extended, the rated loads are determined by boom angle. Use only the column which corresponds to the boom extension length and offset for which the machine is configured. For boom angles not shown, use the rating of the next lower boom angle.
- WARNING:** Operation of this machine with heavier loads than the capacities listed is strictly prohibited. Machine tipping with boom extension occurs rapidly and without advance warning.
- Boom angle is the angle above or below horizontal of the longitudinal axis of the boom base section after lifting rated load.
- Capacities listed are with outriggers properly extended and vertical jacks set only.

NOTE: ( ) Boom angles are in degrees.

A6-829-101337

\*This capacity is based upon maximum boom angle.

#LMI operating code. Refer to LMI manual for instructions.

THIS CHART IS ONLY A GUIDE AND SHOULD NOT BE USED TO OPERATE THE CRANE. The individual crane's load chart, operating instructions and other instructional plates must be read and understood prior to operating the crane.



# Working Range



36 - 110 ft.  
(11 - 33.5 m)

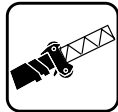

33 ft or 56 ft  
(10.1 m or 17.1 m)



16,500 lbs  
(7 484 Kg)

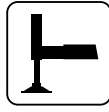

100%



360°

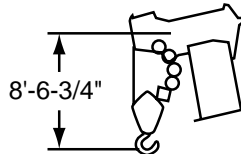
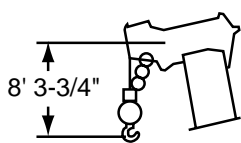
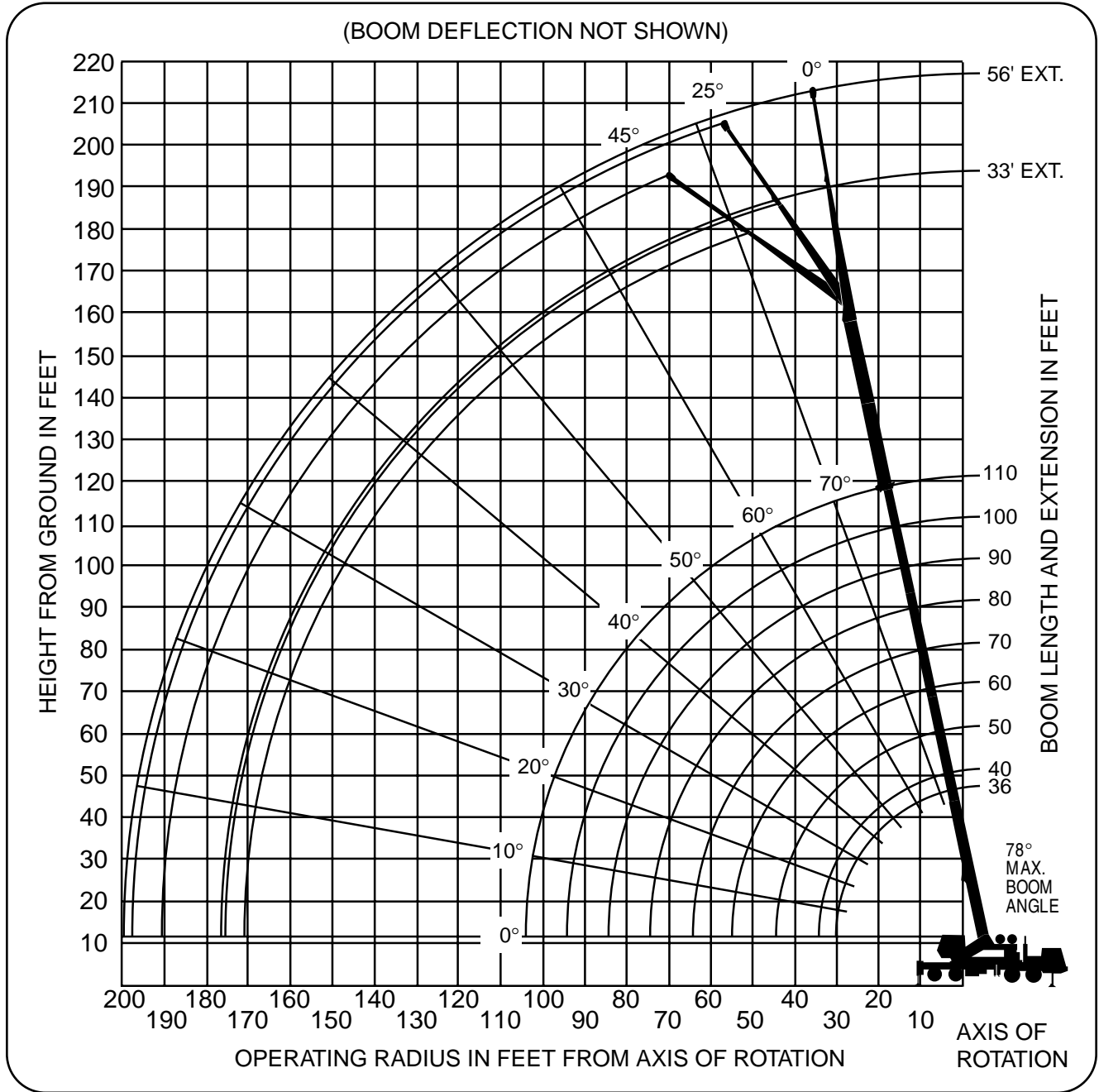

DIMENSIONS ARE FOR LARGEST GROVE FURNISHED HOOK BLOCK AND HEADACHE BALL, WITH ANTI-TWO BLOCK ACTIVATED.

**33 FT. - 56 FT. FOLDING OFFSETTABLE BOOM EXTENSION + 20 FT. INSERT  
WITH 16,500 LB. REMOVABLE COUNTERWEIGHT**

**ON OUTRIGGERS FULLY EXTENDED - 360°**

Radius in Feet	33 ft. LENGTH			56 ft. LENGTH		
	#0064	#0065	#0066	#0084	#0085	#0086
	0° OFFSET	25° OFFSET	45° OFFSET	0° OFFSET	25° OFFSET	45° OFFSET
35	*9,360 (78)					
40	9,360 (77.5)			*6,300 (78)		
45	8,480 (76)	*7,480 (78)		6,300 (77.5)		
50	7,680 (74)	7,070 (77.5)		6,000 (77)		
55	6,990 (72)	6,470 (76)	5,880 (78)	5,990 (75.5)		
60	6,390 (70)	5,970 (74)	5,480 (76.5)	5,980 (73.5)	*4,840 (78)	
65	5,890 (68.5)	5,570 (72.5)	5,080 (74.5)	5,510 (72)	4,840 (77.5)	
70	5,390 (66.5)	5,070 (70.5)	4,780 (72.5)	5,010 (70.5)	4,440 (76.5)	
75	4,990 (64.5)	4,770 (68.5)	4,480 (70.5)	4,560 (68.5)	4,050 (75)	*3,760 (78)
80	4,650 (62.5)	4,400 (66)	4,190 (68)	4,170 (67)	3,870 (73)	3,460 (77)
85	4,300 (60)	4,150 (64)	3,890 (66)	3,820 (65)	3,570 (71.5)	3,260 (75)
90	4,000 (58)	3,850 (62)	3,690 (63.5)	3,520 (63.5)	3,320 (69.5)	2,960 (73)
95	3,760 (56)	3,650 (59.5)	3,500 (61.5)	3,220 (61.5)	3,070 (67.5)	2,770 (71)
100	3,510 (53.5)	3,410 (57.5)	3,300 (59)	2,980 (59.5)	2,880 (66)	2,570 (69)
105	3,260 (51)	3,210 (55)	3,100 (56.5)	2,780 (58)	2,680 (64)	2,460 (67)
110	3,070 (48.5)	3,020 (52.5)	2,930 (54)	2,530 (56)	2,480 (62)	2,340 (65)
115	2,870 (46)	2,870 (50)	2,780 (51)	2,340 (54)	2,280 (60)	2,200 (63)
120	2,550 (43.5)	2,730 (47)		2,190 (52)	2,140 (57.5)	2,050 (60.5)
125	2,170 (40.5)	2,500 (44)		2,000 (49.5)	1,990 (55.5)	1,910 (58)
130	1,820 (37.5)	2,100 (41)		1,850 (47.5)	1,850 (53)	1,810 (55.5)
135	1,500 (34.5)	1,730 (37.5)		1,720 (45)	1,750 (51)	1,670 (53)
140	1,210 (30.5)	1,390 (33.5)		1,480 (42.5)	1,610 (48.5)	
145					1,520 (45.5)	
150					1,370 (43)	
<b>No Load Stability Data</b>						
Min. boom angle at 110' boom length	22°	29°	45°	38°	40°	45°
Max. boom length at 0° boom angle	100 ft.			80 ft.		

1. All capacities above the bold line are based on structural strength of boom extension and do not exceed 85% of tipping loads, in accordance with SAE J-765.
2. 33 ft. and 56 ft. folding boom extension lengths may be used for single line lifting service only.
3. For main boom lengths less than 110 ft. with the boom extension erected, the rated loads are determined by boom angle. Use only the column which corresponds to the boom extension length and offset for which the machine is set up. For boom angles not shown, use rating of the next lower boom angle.
4. **WARNING:** Operation of this machine with heavier loads than the capacities listed is strictly prohibited. Machine tipping with boom extension occurs rapidly and without advance warning.
5. Boom angle is the angle above or below horizontal of the longitudinal axis of the boom base section after lifting rated load.
6. Capacities listed are with outriggers properly extended and vertical jacks set only.

NOTE: ( ) Boom angles are in degrees.

A6-829-101484

\*This capacity is based upon maximum boom angle.

#LMI operating code. Refer to LMI manual for instructions.

THIS CHART IS ONLY A GUIDE AND SHOULD NOT BE USED TO OPERATE THE CRANE. The individual crane's load chart, operating instructions and other instructional plates must be read and understood prior to operating the crane.

## 33 FT. - 56 FT. FOLDING OFFSETTABLE BOOM EXTENSION + 40 FT. INSERT WITH 16,500 LB. REMOVABLE COUNTERWEIGHT

### ON OUTRIGGERS FULLY EXTENDED - 360°

Radius in Feet	33 ft. LENGTH			56 ft. LENGTH		
	#0064	#0065	#0066	#0084	#0085	#0086
	0° OFFSET	25° OFFSET	45° OFFSET	0° OFFSET	25° OFFSET	45° OFFSET
45	6,560 (78)					
50	5,960 (76)			4,510 (78)		
55	5,360 (74.5)	5,860 (78)		4,210 (77.5)		
60	4,860 (73)	5,260 (76.5)	*5,170 (78)	3,910 (76)		
65	4,370 (71)	4,870 (75)	4,670 (77.5)	3,710 (74.5)		
70	3,970 (69.5)	4,370 (73)	4,270 (75.5)	3,410 (73)	*3,710 (78)	
75	3,670 (67.5)	4,070 (71.5)	3,980 (73.5)	3,220 (71.5)	3,420 (77.5)	
80	3,270 (66)	3,670 (69.5)	3,680 (72)	2,820 (70)	3,120 (76)	
85	2,980 (64)	3,370 (68)	3,380 (70)	2,520 (68.5)	2,820 (74.5)	2,730 (77.5)
90	2,780 (62.5)	3,080 (66)	3,080 (68)	2,320 (66.5)	2,620 (72.5)	2,530 (76)
95	2,480 (60.5)	2,880 (64)	2,890 (66)	2,030 (65)	2,330 (71)	2,340 (74.5)
100	2,290 (58.5)	2,580 (62)	2,690 (64)	1,830 (63.5)	2,130 (69.5)	2,140 (72.5)
105	2,090 (56.5)	2,390 (60)	2,390 (62)	1,630 (62)	1,930 (68)	1,940 (71)
110	1,900 (54.5)	2,190 (58)	2,200 (60)	1,440 (60)	1,730 (66)	1,740 (69)
115	1,700 (52.5)	2,000 (56)	2,100 (58)	1,240 (58.5)	1,540 (64.5)	1,550 (67)
120	1,600 (50.5)	1,800 (54)	1,910 (55.5)	1,140 (57)	1,340 (62.5)	1,450 (65)
125	1,410 (48)	1,700 (51.5)	1,710 (53)		1,240 (61)	1,260 (63.5)
130	1,310 (46)	1,510 (49.5)	1,520 (50.5)		1,050 (59)	1,160 (61.5)
135	1,120 (43.5)	1,420 (47)	1,420 (48)			
140	1,030 (41)	1,220 (44.5)				
145		1,070 (41.5)				
<b>No Load Stability Data</b>						
Min. boom angle at 110' boom length	40°	40°	47°	56°	58°	60°
Max. boom length at 0° boom angle	70 ft.			40 ft.		

NOTE: ( ) Boom angles are in degrees.

A6-829-101494

\*This capacity is based upon maximum boom angle.

#LMI operating code. Refer to LMI manual for instructions.

1. All capacities above the bold line are based on structural strength of boom extension and do not exceed 85% of tipping loads, in accordance with SAE J-765.
2. 33 ft. and 56 ft. folding boom extension lengths may be used for single line lifting service only.
3. For main boom lengths less than 110 ft. with the boom extension erected, the rated loads are determined by boom angle. Use only the column which corresponds to the boom extension length and offset for which the machine is set up. For boom angles not shown, use rating of the next lower boom angle.
4. **WARNING:** Operation of this machine with heavier loads than the capacities listed is strictly prohibited. Machine tipping with boom extension occurs rapidly and without advance warning.
5. Boom angle is the angle above or below horizontal of the longitudinal axis of the boom base section after lifting rated load.
6. Capacities listed are with outriggers properly extended and vertical jacks set only.

THIS CHART IS ONLY A GUIDE AND SHOULD NOT BE USED TO OPERATE THE CRANE. The individual crane's load chart, operating instructions and other instructional plates must be read and understood prior to operating the crane.

**RATED LIFTING CAPACITIES IN POUNDS  
WITH 11,000 LB. REMOVABLE COUNTERWEIGHT  
36 FT. - 110 FT. BOOM**

**ON OUTRIGGERS FULLY EXTENDED - 360°**

Radius in Feet	#0101								
	Main Boom Length in Feet								
	36	40	50	**60	70	80	90	100	110
10	90,000 (69)	84,400 (72)	80,200 (76)	*62,500 (78)					
12	90,000 (65.5)	84,400 (68.5)	80,200 (73.5)	62,500 (77)	*36,800 (78)				
15	87,300 (59.5)	82,700 (63.5)	80,200 (70)	61,000 (74)	36,800 (76.5)	*36,800 (78)	*31,000 (78)		
20	68,250 (49)	65,000 (55)	64,300 (63.5)	50,650 (69)	36,800 (72)	36,800 (75)	31,000 (77)	*29,100 (78)	*24,000 (78)
25	48,550 (36)	48,350 (45)	47,650 (56.5)	41,800 (63.5)	36,800 (68)	34,000 (71)	30,000 (73.5)	27,000 (76)	24,000 (77.5)
30		34,300 (31.5)	33,650 (48.5)	32,800 (57.5)	33,400 (63)	29,000 (67)	25,300 (70.5)	24,200 (72.5)	22,000 (75)
35	See Note 16		25,250 (40)	24,350 (51.5)	25,000 (58)	25,000 (63)	22,200 (67)	21,750 (69.5)	20,000 (72)
40			19,500 (28)	18,700 (45)	19,350 (53)	20,050 (59)	20,200 (63)	19,000 (66.5)	18,500 (69)
45				14,650 (37)	15,350 (47.5)	16,050 (54.5)	16,750 (59.5)	17,300 (63)	17,300 (66.5)
50				11,550 (26.5)	12,350 (41)	13,050 (49.5)	13,750 (55.5)	14,300 (60)	14,850 (63.5)
55					9,960 (33.5)	10,700 (44.5)	11,450 (51)	11,900 (56.5)	12,400 (60)
60					8,040 (24)	8,850 (38.5)	9,590 (47)	10,000 (52.5)	10,400 (57)
65						7,280 (31.5)	8,070 (42)	8,450 (48.5)	8,830 (53.5)
70						5,970 (22.5)	6,760 (36.5)	7,140 (44.5)	7,480 (50)
75							5,660 (30)	6,020 (40)	6,350 (46.5)
80							4,710 (21.5)	5,050 (34.5)	5,370 (42.5)
85								4,200 (28.5)	4,510 (38)
90								3,460 (20.5)	3,750 (33)
95									3,080 (27.5)
100									2,480 (19.5)
Minimum boom angle (deg.) for indicated length (no load)								0	
Maximum boom length (ft.) at 0 degree boom angle (no load)								1	10

NOTE: ( ) Boom angles are in degrees.  
#LMI operating code. Refer to LMI manual for instructions.  
\*This capacity is based on maximum boom angle.

Lifting Capacities at Zero Degree Boom Angle									
Boom Angle	Main Boom Length in Feet								
	36	40	50	**60	70	80	90	100	110
0°	29,050 (29.8)	24,450 (34.2)	16,000 (44.2)	9,340 (54.6)	6,710 (64.2)	5,030 (74.2)	4,020 (84.2)	2,920 (94.2)	2,030 (104.2)

NOTE: ( ) Reference radii in feet.

A6-829-101846

\*\*60 ft. boom length is with inner-mid extended and outer-mid & fly retracted.

THIS CHART IS ONLY A GUIDE AND SHOULD NOT BE USED TO OPERATE THE CRANE. The individual crane's load chart, operating instructions and other instructional plates must be read and understood prior to operating the crane.

**RATED LIFTING CAPACITIES IN POUNDS  
WITH 11,000 LB. REMOVABLE COUNTERWEIGHT  
36 FT. - 110 FT. BOOM**

**ON OUTRIGGERS FULLY EXTENDED - OVER REAR**

Radius in Feet	#0101								
	Main Boom Length in Feet								
	36	40	50	**60	70	80	90	100	110
10	90,000 (69)	84,400 (72)	80,200 (76)	*62,500 (78)					
12	90,000 (65.5)	84,400 (68.5)	80,200 (73.5)	62,500 (77)	*36,800 (78)				
15	87,300 (59.5)	82,700 (63.5)	80,200 (70)	61,000 (74)	36,800 (76.5)	*36,800 (78)	*31,000 (78)		
20	68,250 (49)	65,000 (55)	64,300 (63.5)	50,650 (69)	36,800 (72)	36,800 (75)	31,000 (77)	*29,100 (78)	*24,000 (78)
25	52,900 (36)	52,700 (45)	52,000 (56.5)	41,800 (63.5)	36,800 (68)	34,000 (71)	30,000 (73.5)	27,000 (76)	24,000 (77.5)
30		41,750 (31.5)	39,600 (48.5)	38,000 (57.5)	33,400 (63)	29,000 (67)	25,300 (70.5)	24,200 (72.5)	22,000 (75)
35	See Note 16		32,400 (40)	29,750 (51.5)	28,700 (58)	25,000 (63)	22,200 (67)	21,750 (69.5)	20,000 (72)
40			26,050 (28)	25,500 (45)	23,600 (53)	22,000 (59)	20,200 (63)	19,000 (66.5)	18,500 (69)
45				20,000 (37)	19,700 (47.5)	18,800 (54.5)	17,800 (59.5)	17,300 (63)	17,300 (66.5)
50				16,650 (26.5)	16,800 (41)	16,500 (49.5)	16,000 (55.5)	16,000 (60)	16,000 (63.5)
55					14,500 (33.5)	14,650 (44.5)	14,100 (51)	14,100 (56.5)	14,100 (60)
60					12,100 (24)	12,800 (38.5)	12,200 (47)	12,200 (52.5)	12,200 (57)
65						10,950 (31.5)	10,800 (42)	10,600 (48.5)	10,600 (53.5)
70						9,290 (22.5)	9,450 (36.5)	9,000 (44.5)	9,000 (50)
75							8,290 (30)	7,800 (40)	7,800 (46.5)
80							7,140 (21.5)	6,600 (34.5)	6,600 (42.5)
85								5,800 (28.5)	5,800 (38)
90								5,000 (20.5)	5,000 (33)
95									4,440 (27.5)
100									3,880 (19.5)
Minimum boom angle (deg.) for indicated length (no load)								0	
Maximum boom length (ft.) at 0 degree boom angle (no load)								1	10

NOTE: ( ) Boom angles are in degrees.  
#LMI operating code. Refer to LMI manual for instructions.  
\*This capacity is based on maximum boom angle.

Lifting Capacities at Zero Degree Boom Angle									
Boom Angle	Main Boom Length in Feet								
	36	40	50	**60	70	80	90	100	110
0°	29,050 (29.8)	24,450 (34.2)	17,050 (44.2)	11,950 (54.6)	9,640 (64.2)	7,810 (74.2)	6,390 (84.2)	4,770 (94.2)	3,350 (104.2)

NOTE: ( ) Reference radii in feet. A6-829-101847

\*\*60 ft. boom length is with inner-mid extended and outer-mid & fly retracted.

THIS CHART IS ONLY A GUIDE AND SHOULD NOT BE USED TO OPERATE THE CRANE. The individual crane's load chart, operating instructions and other instructional plates must be read and understood prior to operating the crane.

# 33 FT. - 56 FT. FOLDING OFFSETTABLE BOOM EXTENSION WITH 11,000 LB. REMOVABLE COUNTERWEIGHT

## ON OUTRIGGERS FULLY EXTENDED - 360°

Radius in Feet	33 ft. LENGTH			56 ft. LENGTH		
	#0121	#0122	#0123	#0141	#0142	#0143
	0° OFFSET	25° OFFSET	45° OFFSET	0° OFFSET	25° OFFSET	45° OFFSET
30	12,900 (78)					
35	12,900 (76)			*8,330 (78)		
40	12,900 (74)	*10,850 (78)		8,330 (77.5)		
45	12,900 (72)	10,450 (77)	*7,410 (78)	8,330 (76)		
50	12,100 (70)	10,000 (74.5)	7,200 (77.5)	8,330 (74.5)		
55	11,100 (68)	9,220 (72.5)	6,990 (75)	8,250 (73)	*5,300 (78)	
60	10,100 (66)	8,550 (70.5)	6,800 (72.5)	7,540 (71)	5,140 (77)	
65	9,130 (63.5)	7,930 (68)	6,650 (70.5)	7,160 (69)	5,100 (75)	*3,860 (78)
70	7,960 (61.5)	7,380 (65.5)	6,490 (68)	6,820 (67.5)	5,100 (73)	3,790 (77.5)
75	6,870 (59)	6,900 (63)	6,370 (65.5)	6,300 (65.5)	4,800 (71)	3,660 (75)
80	5,930 (56.5)	6,470 (60.5)	6,110 (62.5)	5,810 (63.5)	4,580 (69)	3,550 (73)
85	5,120 (54)	5,880 (58)	5,780 (60)	5,370 (61.5)	4,470 (67.5)	3,450 (71)
90	4,410 (51)	5,070 (55.5)	5,440 (57)	4,960 (59.5)	4,330 (65.5)	3,410 (68.5)
95	3,780 (48.5)	4,350 (52.5)	4,680 (54)	4,310 (57)	4,070 (63)	3,300 (66.5)
100	3,230 (45.5)	3,710 (49.5)	4,010 (51)	3,730 (55)	3,830 (61)	3,260 (64)
105	2,730 (42.5)	3,140 (46.5)	3,410 (47.5)	3,210 (52.5)	3,620 (58.5)	3,220 (62)
110	2,280 (39.5)	2,630 (43)		2,750 (50.5)	3,410 (56)	3,180 (59.5)
115	1,870 (36)	2,170 (39.5)		2,330 (48)	3,020 (53.5)	3,060 (56.5)
120	1,500 (32)	1,750 (35)		1,940 (45.5)	2,550 (51)	2,800 (53.5)
125	1,170 (27.5)	1,360 (30.5)		1,590 (42.5)	2,130 (48.5)	2,330 (50.5)
130				1,270 (39.5)	1,740 (45.5)	
135					1,390 (42.5)	
140					1,060 (38.5)	
No Load Stability Data						
Min. boom angle for indicated length	25°	25°	45°	33°	36°	45°
Max. boom length at 0° boom angle	90 ft.			80 ft.		

- All capacities above the bold line are based on structural strength of boom extension.
- 33 ft. and 56 ft. boom extension lengths may be used for single line lifting service.
- Radii listed are for a fully extended boom with the boom extension erected. For main boom lengths less than fully extended, the rated loads are determined by boom angle. Use only the column which corresponds to the boom extension length and offset for which the machine is configured. For boom angles not shown, use the rating of the next lower boom angle.
- WARNING:** Operation of this machine with heavier loads than the capacities listed is strictly prohibited. Machine tipping with boom extension occurs rapidly and without advance warning.
- Boom angle is the angle above or below horizontal of the longitudinal axis of the boom base section after lifting rated load.
- Capacities listed are with outriggers properly extended and vertical jacks set only.

NOTE: ( ) Boom angles are in degrees.

A6-829-101338

\*This capacity is based upon maximum boom angle.

#LMI operating code. Refer to LMI manual for instructions.

THIS CHART IS ONLY A GUIDE AND SHOULD NOT BE USED TO OPERATE THE CRANE. The individual crane's load chart, operating instructions and other instructional plates must be read and understood prior to operating the crane.

**RATED LIFTING CAPACITIES IN POUNDS  
WITH 5,500 LB. REMOVABLE COUNTERWEIGHT  
36 FT. - 110 FT. BOOM**

**ON OUTRIGGERS FULLY EXTENDED - 360°**

Radius in Feet	#0201								
	Main Boom Length in Feet								
	36	40	50	**60	70	80	90	100	110
10	90,000 (69)	84,400 (72)	80,200 (76)	*62,500 (78)					
12	90,000 (65.5)	84,400 (68.5)	80,200 (73.5)	62,500 (77)	*36,800 (78)				
15	87,300 (59.5)	82,700 (63.5)	80,200 (70)	61,000 (74)	36,800 (76.5)	*36,800 (78)	*31,000 (78)		
20	66,000 (49)	65,000 (55)	64,300 (63.5)	50,650 (69)	36,800 (72)	36,800 (75)	31,000 (77)	*29,100 (78)	*24,000 (78)
25	41,100 (36)	41,000 (45)	40,600 (56.5)	40,150 (63.5)	36,800 (68)	34,000 (71)	30,000 (73.5)	27,000 (76)	24,000 (77.5)
30		28,400 (31.5)	28,150 (48.5)	27,750 (57.5)	28,450 (63)	29,000 (67)	25,300 (70.5)	24,200 (72.5)	22,000 (75)
35	See Note 16		20,700 (40)	20,300 (51.5)	21,000 (58)	21,750 (63)	22,200 (67)	21,750 (69.5)	20,000 (72)
40			15,600 (28)	15,350 (45)	16,050 (53)	16,750 (59)	17,500 (63)	17,900 (66.5)	18,300 (69)
45				11,750 (37)	12,500 (47.5)	13,200 (54.5)	13,950 (59.5)	14,300 (63)	14,700 (66.5)
50				9,040 (26.5)	9,850 (41)	10,550 (49.5)	11,250 (55.5)	11,650 (60)	12,000 (63.5)
55					7,720 (33.5)	8,500 (44.5)	9,210 (51)	9,570 (56.5)	9,940 (60)
60					6,010 (24)	6,810 (38.5)	7,550 (47)	7,900 (52.5)	8,260 (57)
65						5,410 (31.5)	6,190 (42)	6,540 (48.5)	6,880 (53.5)
70						4,250 (22.5)	5,020 (36.5)	5,400 (44.5)	5,740 (50)
75							4,030 (30)	4,420 (40)	4,770 (46.5)
80							3,190 (21.5)	3,570 (34.5)	3,940 (42.5)
85								2,830 (28.5)	3,200 (38)
90								2,180 (20.5)	2,550 (33)
95									1,980 (27.5)
100									1,470 (19.5)
Minimum boom angle (deg.) for indicated length (no load)								0	
Maximum boom length (ft.) at 0 degree boom angle (no load)								1	10

NOTE: ( ) Boom angles are in degrees.  
#LMI operating code. Refer to LMI manual for instructions.  
\*This capacity is based on maximum boom angle.

Lifting Capacities at Zero Degree Boom Angle									
Boom Angle	Main Boom Length in Feet								
	36	40	50	**60	70	80	90	100	110
0°	28,850 (29.8)	21,800 (34.2)	12,500 (44.2)	7,080 (54.6)	4,830 (64.2)	3,410 (74.2)	2,570 (84.2)	1,710 (94.2)	1,080 (104.2)

NOTE: ( ) Reference radii in feet.

A6-829-101848

\*\*60 ft. boom length is with inner-mid extended and outer-mid & fly retracted.

THIS CHART IS ONLY A GUIDE AND SHOULD NOT BE USED TO OPERATE THE CRANE. The individual crane's load chart, operating instructions and other instructional plates must be read and understood prior to operating the crane.

**RATED LIFTING CAPACITIES IN POUNDS  
WITH 5,500 LB. REMOVABLE COUNTERWEIGHT  
36 FT. - 110 FT. BOOM**

**ON OUTRIGGERS FULLY EXTENDED - OVER REAR**

Radius in Feet	#0201								
	Main Boom Length in Feet								
	36	40	50	**60	70	80	90	100	110
10	90,000 (69)	84,400 (72)	80,200 (76)	*62,500 (78)					
12	90,000 (65.5)	84,400 (68.5)	80,200 (73.5)	62,500 (77)	*36,800 (78)				
15	87,300 (59.5)	82,700 (63.5)	80,200 (70)	61,000 (74)	36,800 (76.5)	*36,800 (78)	*31,000 (78)		
20	66,000 (49)	65,000 (55)	64,300 (63.5)	50,650 (69)	36,800 (72)	36,800 (75)	31,000 (77)	*29,100 (78)	*24,000 (78)
25	50,050 (36)	49,850 (45)	49,500 (56.5)	41,800 (63.5)	36,800 (68)	34,000 (71)	30,000 (73.5)	27,000 (76)	24,000 (77.5)
30		38,100 (31.5)	38,200 (48.5)	38,000 (57.5)	33,400 (63)	29,000 (67)	25,300 (70.5)	24,200 (72.5)	22,000 (75)
35	See Note 16		28,700 (40)	28,600 (51.5)	28,700 (58)	25,000 (63)	22,200 (67)	21,750 (69.5)	20,000 (72)
40			22,200 (28)	22,200 (45)	23,000 (53)	22,000 (59)	20,200 (63)	19,000 (66.5)	18,500 (69)
45				17,600 (37)	18,400 (47.5)	18,800 (54.5)	17,800 (59.5)	17,300 (63)	17,300 (66.5)
50				14,100 (26.5)	14,950 (41)	15,750 (49.5)	16,000 (55.5)	16,000 (60)	16,000 (63.5)
55					12,250 (33.5)	13,050 (44.5)	13,800 (51)	14,100 (56.5)	14,100 (60)
60					10,050 (24)	10,900 (38.5)	11,650 (47)	12,000 (52.5)	12,200 (57)
65						9,100 (31.5)	9,890 (42)	10,200 (48.5)	10,550 (53.5)
70						7,590 (22.5)	8,380 (36.5)	8,740 (44.5)	9,000 (50)
75							7,100 (30)	7,480 (40)	7,800 (46.5)
80							5,990 (21.5)	6,370 (34.5)	6,600 (42.5)
85								5,410 (28.5)	5,770 (38)
90								4,570 (20.5)	4,920 (33)
95									4,180 (27.5)
100									3,520 (19.5)
Minimum boom angle (deg.) for indicated length (no load)								0	
Maximum boom length (ft.) at 0 degree boom angle (no load)								1	10

NOTE: ( ) Boom angles are in degrees.  
#LMI operating code. Refer to LMI manual for instructions.  
\*This capacity is based on maximum boom angle.

Lifting Capacities at Zero Degree Boom Angle									
Boom Angle	Main Boom Length in Feet								
	36	40	50	**60	70	80	90	100	110
0°	29,050 (29.8)	24,450 (34.2)	17,050 (44.2)	11,600 (54.6)	8,550 (64.2)	6,520 (74.2)	5,190 (84.2)	3,950 (94.2)	3,020 (104.2)

NOTE: ( ) Reference radii in feet. A6-829-101849

\*\*60 ft. boom length is with inner-mid extended and outer-mid & fly retracted.

THIS CHART IS ONLY A GUIDE AND SHOULD NOT BE USED TO OPERATE THE CRANE. The individual crane's load chart, operating instructions and other instructional plates must be read and understood prior to operating the crane.



# 33 FT. - 56 FT. FOLDING OFFSETTABLE BOOM EXTENSION WITH 5,500 LB. REMOVABLE COUNTERWEIGHT

## ON OUTRIGGERS FULLY EXTENDED - 360°

Radius in Feet	33 ft. LENGTH			56 ft. LENGTH		
	#0221	#0222	#0223	#0241	#0242	#0243
	0° OFFSET	25° OFFSET	45° OFFSET	0° OFFSET	25° OFFSET	45° OFFSET
30	12,900 (78)					
35	12,900 (76)			*8,330 (78)		
40	12,900 (74)	*10,850 (78)		8,330 (77.5)		
45	12,900 (72)	10,450 (77)	*7,410 (78)	8,330 (76)		
50	12,100 (70)	10,000 (74.5)	7,200 (77.5)	8,330 (74.5)		
55	10,450 (68)	9,220 (72.5)	6,990 (75)	8,250 (73)	*5,300 (78)	
60	8,780 (66)	8,550 (70.5)	6,800 (72.5)	7,540 (71)	5,140 (77)	
65	7,420 (63.5)	7,930 (68)	6,650 (70.5)	7,160 (69)	5,100 (75)	*3,860 (78)
70	6,280 (61.5)	7,260 (65.5)	6,490 (68)	6,820 (67.5)	5,100 (73)	3,790 (77.5)
75	5,310 (59)	6,180 (63)	6,370 (65.5)	6,030 (65.5)	4,800 (71)	3,660 (75)
80	4,490 (56.5)	5,250 (60.5)	5,840 (62.5)	5,150 (63.5)	4,580 (69)	3,550 (73)
85	3,770 (54)	4,450 (58)	4,950 (60)	4,400 (61.5)	4,470 (67.5)	3,450 (71)
90	3,150 (51)	3,750 (55.5)	4,180 (57)	3,730 (59.5)	4,330 (65.5)	3,410 (68.5)
95	2,590 (48.5)	3,130 (52.5)	3,490 (54)	3,140 (57)	4,070 (63)	3,300 (66.5)
100	2,100 (45.5)	2,580 (49.5)	2,890 (51)	2,620 (55)	3,590 (61)	3,260 (64)
105	1,660 (42.5)	2,080 (46.5)	2,340 (47.5)	2,160 (52.5)	3,030 (58.5)	3,220 (62)
110	1,270 (39.5)	1,640 (43)		1,740 (50.5)	2,520 (56)	2,880 (59.5)
115		1,240 (39.5)		1,360 (48)	2,050 (53.5)	2,360 (56.5)
120				1,010 (45.5)	1,640 (51)	1,890 (53.5)
125					1,250 (48.5)	1,450 (50.5)
<b>No Load Stability Data</b>						
Min. boom angle for indicated length	37°	37°	45°	45°	46°	48°
Max. boom length at 0° boom angle	80 ft.			60 ft.		

NOTE: ( ) Boom angles are in degrees.

A6-829-101339

\*This capacity is based upon maximum boom angle.

#LMI operating code. Refer to LMI manual for instructions.

1. All capacities above the bold line are based on structural strength of boom extension.
2. 33 ft. and 56 ft. boom extension lengths may be used for single line lifting service.
3. Radii listed are for a fully extended boom with the boom extension erected. For main boom lengths less than fully extended, the rated loads are determined by boom angle. Use only the column which corresponds to the boom extension length and offset for which the machine is configured. For boom angles not shown, use the rating of the next lower boom angle.
4. **WARNING:** Operation of this machine with heavier loads than the capacities listed is strictly prohibited. Machine tipping with boom extension occurs rapidly and without advance warning.
5. Boom angle is the angle above or below horizontal of the longitudinal axis of the boom base section after lifting rated load.
6. Capacities listed are with outriggers properly extended and vertical jacks set only.

THIS CHART IS ONLY A GUIDE AND SHOULD NOT BE USED TO OPERATE THE CRANE. The individual crane's load chart, operating instructions and other instructional plates must be read and understood prior to operating the crane.

**RATED LIFTING CAPACITIES IN POUNDS  
WITH NO REMOVABLE COUNTERWEIGHT  
36 FT. - 110 FT. BOOM**

**ON OUTRIGGERS FULLY EXTENDED - 360°**

Radius in Feet	#0801								
	Main Boom Length in Feet								
	36	40	50	**60	70	80	90	100	110
10	90,000 (69)	84,400 (72)	80,200 (76)	*62,500 (78)					
12	90,000 (65.5)	84,400 (68.5)	80,200 (73.5)	62,500 (77)	*36,800 (78)				
15	87,300 (59.5)	82,700 (63.5)	80,200 (70)	61,000 (74)	36,800 (76.5)	*36,800 (78)	*31,000 (78)		
20	56,000 (49)	55,750 (55)	55,300 (63.5)	50,650 (69)	36,800 (72)	36,800 (75)	31,000 (77)	*29,100 (78)	*24,000 (78)
25	34,350 (36)	34,300 (45)	33,850 (56.5)	33,400 (63.5)	34,100 (68)	34,000 (71)	30,000 (73.5)	27,000 (76)	24,000 (77.5)
30		23,350 (31.5)	23,100 (48.5)	22,700 (57.5)	23,400 (63)	24,150 (67)	24,850 (70.5)	24,200 (72.5)	22,000 (75)
35	See Note 16		16,650 (40)	16,250 (51.5)	16,950 (58)	17,700 (63)	18,400 (67)	18,850 (69.5)	19,300 (72)
40			12,250 (28)	12,000 (45)	12,650 (53)	13,400 (59)	14,100 (63)	14,550 (66.5)	14,950 (69)
45				8,890 (37)	9,620 (47.5)	10,300 (54.5)	11,050 (59.5)	11,450 (63)	11,800 (66.5)
50				6,510 (26.5)	7,330 (41)	8,040 (49.5)	8,750 (55.5)	9,130 (60)	9,510 (63.5)
55					5,470 (33.5)	6,250 (44.5)	6,960 (51)	7,320 (56.5)	7,690 (60)
60					3,990 (24)	4,790 (38.5)	5,530 (47)	5,880 (52.5)	6,240 (57)
65						3,580 (31.5)	4,350 (42)	4,700 (48.5)	5,050 (53.5)
70						2,560 (22.5)	3,340 (36.5)	3,710 (44.5)	4,060 (50)
75							2,480 (30)	2,870 (40)	3,220 (46.5)
80							1,740 (21.5)	2,130 (34.5)	2,500 (42.5)
85								1,480 (28.5)	1,850 (38)
90									1,290 (33)
Minimum boom angle (deg.) for indicated length (no load)								14	26
Maximum boom length (ft.) at 0 degree boom angle (no load)								90	

NOTE: ( ) Boom angles are in degrees.  
#LMI operating code. Refer to LMI manual for instructions.  
\*This capacity is based on maximum boom angle.

Lifting Capacities at Zero Degree Boom Angle									
Boom Angle	Main Boom Length in Feet								
	36	40	50	**60	70	80	90		
0°	23,700 (29.8)	17,650 (34.2)	9,550 (44.2)	4,810 (54.6)	2,960 (64.2)	1,840 (74.2)	1,210 (84.2)		

NOTE: ( ) Reference radii in feet.

A6-829-101850

\*\*60 ft. boom length is with inner-mid extended and outer-mid & fly retracted.

THIS CHART IS ONLY A GUIDE AND SHOULD NOT BE USED TO OPERATE THE CRANE. The individual crane's load chart, operating instructions and other instructional plates must be read and understood prior to operating the crane.

**RATED LIFTING CAPACITIES IN POUNDS  
WITH NO REMOVABLE COUNTERWEIGHT  
36 FT. - 110 FT. BOOM**

**ON OUTRIGGERS FULLY EXTENDED - OVER REAR**

Radius in Feet	#0801								
	Main Boom Length in Feet								
	36	40	50	**60	70	80	90	100	110
10	90,000 (69)	84,400 (72)	80,200 (76)	*62,500 (78)					
12	90,000 (65.5)	84,400 (68.5)	80,200 (73.5)	62,500 (77)	*36,800 (78)				
15	87,300 (59.5)	82,700 (63.5)	80,200 (70)	61,000 (74)	36,800 (76.5)	*36,800 (78)	*31,000 (78)		
20	62,400 (49)	62,200 (55)	61,800 (63.5)	50,650 (69)	36,800 (72)	36,800 (75)	31,000 (77)	*29,100 (78)	*24,000 (78)
25	47,250 (36)	47,050 (45)	46,700 (56.5)	41,800 (63.5)	36,800 (68)	34,000 (71)	30,000 (73.5)	27,000 (76)	24,000 (77.5)
30		32,950 (31.5)	33,100 (48.5)	33,050 (57.5)	33,400 (63)	29,000 (67)	25,300 (70.5)	24,200 (72.5)	22,000 (75)
35	See Note 16		24,600 (40)	24,500 (51.5)	25,350 (58)	25,000 (63)	22,200 (67)	21,750 (69.5)	20,000 (72)
40			18,800 (28)	18,750 (45)	19,600 (53)	20,450 (59)	20,200 (63)	19,000 (66.5)	18,500 (69)
45				14,650 (37)	15,500 (47.5)	16,300 (54.5)	17,100 (59.5)	17,300 (63)	17,300 (66.5)
50				11,550 (26.5)	12,400 (41)	13,200 (49.5)	14,000 (55.5)	14,350 (60)	14,750 (63.5)
55					9,990 (33.5)	10,800 (44.5)	11,550 (51)	11,900 (56.5)	12,300 (60)
60					8,020 (24)	8,860 (38.5)	9,620 (47)	9,980 (52.5)	10,300 (57)
65						7,240 (31.5)	8,030 (42)	8,370 (48.5)	8,720 (53.5)
70						5,890 (22.5)	6,680 (36.5)	7,040 (44.5)	7,380 (50)
75							5,520 (30)	5,910 (40)	6,240 (46.5)
80							4,540 (21.5)	4,910 (34.5)	5,270 (42.5)
85								4,050 (28.5)	4,410 (38)
90								3,300 (20.5)	3,650 (33)
95									2,980 (27.5)
100									2,380 (19.5)
Minimum boom angle (deg.) for indicated length (no load)								0	
Maximum boom length (ft.) at 0 degree boom angle (no load)								1	10

NOTE: ( ) Boom angles are in degrees.  
 #LMI operating code. Refer to LMI manual for instructions.  
 \*This capacity is based on maximum boom angle.

Lifting Capacities at Zero Degree Boom Angle									
Boom Angle	Main Boom Length in Feet								
	36	40	50	**60	70	80	90	100	110
0°	29,050 (29.8)	24,450 (34.2)	15,250 (44.2)	9,320 (54.6)	6,660 (64.2)	4,930 (74.2)	3,820 (84.2)	2,740 (94.2)	1,940 (104.2)

NOTE: ( ) Reference radii in feet.

A6-829-101851

\*\*60 ft. boom length is with inner-mid extended and outer-mid & fly retracted.

THIS CHART IS ONLY A GUIDE AND SHOULD NOT BE USED TO OPERATE THE CRANE. The individual crane's load chart, operating instructions and other instructional plates must be read and understood prior to operating the crane.

# 33 FT. - 56 FT. FOLDING OFFSETTABLE BOOM EXTENSION WITH NO REMOVABLE COUNTERWEIGHT

ON OUTRIGGERS FULLY EXTENDED - 360°

Radius in Feet	33 ft. LENGTH			56 ft. LENGTH		
	#0821	#0822	#0823	#0841	#0842	#0843
	0° OFFSET	25° OFFSET	45° OFFSET	0° OFFSET	25° OFFSET	45° OFFSET
30	12,900 (78)					
35	12,900 (76)			*8,330 (78)		
40	12,900 (74)	*10,850 (78)		8,330 (77.5)		
45	12,800 (72)	10,450 (77)	*7,410 (78)	8,330 (76)		
50	10,350 (70)	10,000 (74.5)	7,200 (77.5)	8,330 (74.5)		
55	8,510 (68)	9,220 (72.5)	6,990 (75)	8,250 (73)	*5,300 (78)	
60	7,000 (66)	8,330 (70.5)	6,800 (72.5)	7,540 (71)	5,140 (77)	
65	5,770 (63.5)	6,930 (68)	6,650 (70.5)	6,420 (69)	5,100 (75)	*3,860 (78)
70	4,740 (61.5)	5,760 (65.5)	6,370 (68)	5,370 (67.5)	5,100 (73)	3,790 (77.5)
75	3,870 (59)	4,770 (63)	5,310 (65.5)	4,480 (65.5)	4,800 (71)	3,660 (75)
80	3,130 (56.5)	3,920 (60.5)	4,390 (62.5)	3,710 (63.5)	4,580 (69)	3,550 (73)
85	2,480 (54)	3,180 (58)	3,610 (60)	3,050 (61.5)	4,110 (67.5)	3,450 (71)
90	1,920 (51)	2,540 (55.5)	2,910 (57)	2,470 (59.5)	3,450 (65.5)	3,410 (68.5)
95	1,420 (48.5)	1,970 (52.5)	2,310 (54)	1,960 (57)	2,860 (63)	3,300 (66.5)
100		1,470 (49.5)	1,760 (51)	1,500 (55)	2,330 (61)	2,980 (64)
105		1,020 (46.5)	1,280 (47.5)	1,090 (52.5)	1,870 (58.5)	2,390 (62)
110					1,450 (56)	1,870 (59.5)
115					1,060 (53.5)	1,400 (56.5)
<b>No Load Stability Data</b>						
Min. boom angle for indicated length	46°	45°	45°	48°	51°	51°
Max. boom length at 0° boom angle	60 ft.			50 ft.		

1. All capacities above the bold line are based on structural strength of boom extension.
2. 33 ft. and 56 ft. boom extension lengths may be used for single line lifting service.
3. Radii listed are for a fully extended boom with the boom extension erected. For main boom lengths less than fully extended, the rated loads are determined by boom angle. Use only the column which corresponds to the boom extension length and offset for which the machine is configured. For boom angles not shown, use the rating of the next lower boom angle.
4. **WARNING:** Operation of this machine with heavier loads than the capacities listed is strictly prohibited. Machine tipping with boom extension occurs rapidly and without advance warning.
5. Boom angle is the angle above or below horizontal of the longitudinal axis of the boom base section after lifting rated load.
6. Capacities listed are with outriggers properly extended and vertical jacks set only.

NOTE: ( ) Boom angles are in degrees.

A6-829-101340

\*This capacity is based upon maximum boom angle.

#LMI operating code. Refer to LMI manual for instructions.

## Counterweight Configurations

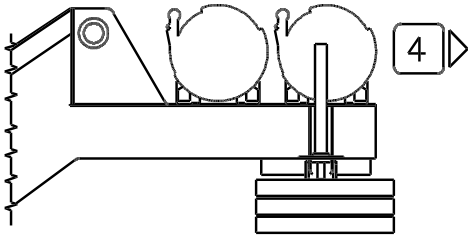

MAXIMUM COUNTERWEIGHT - 16,500 lb (7 485 kg)

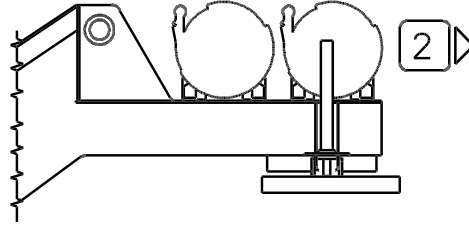

PARTIAL COUNTERWEIGHT - 5,500 lb (2 495 kg)

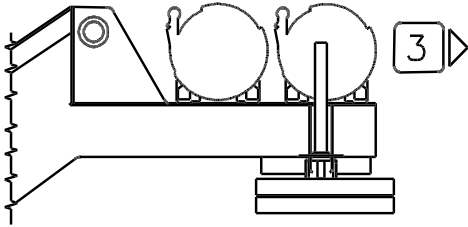

PARTIAL COUNTERWEIGHT - 11,000 lb (4 990 kg)

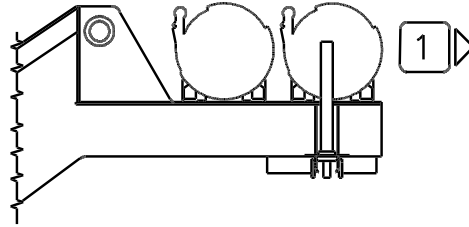

NO COUNTERWEIGHT

LMI  
CONSOLE  
COUNTER-  
WEIGHT  
OPTION  
  
SELECTION  
BUTTON

	GVW		Front		Rear	
	lbs	kg	lbs	kg	lbs	kg
<b>Axle/Tire Allowable Weights</b>	109,200	49,533	49,200	22,317	60,000	27,216
<b>TMS745E Basic Machine</b> with main and aux hoists w/ rope, bifold swingaway, aux boom nose, 40 ton block, 8.3 ton ball, NO counterweight	77,970	35,367	41,398	18,778	36,572	16,589
<b>Add:</b> 5,500 lbs counterweight ( 1 piece on s/s)	5,500	2,495	-2,214	-1,004	7,714	3,499
<b>Add:</b> 11,000 lbs counterweight ( 2 pieces on s/s)	11,000	4,990	-4,428	-2,009	15,428	6,998
<b>Add:</b> 11,000 lbs counterweight ( 1 piece on s/s; 1 piece on chassis)	11,000	4,990	2,478	1,124	8,522	3,866
<b>Add:</b> 16,500 lbs counterweight ( 2 pieces on s/s; 1 piece on chassis)	16,500	7,484	264	120	16,236	7,365
<b>Sub:</b> 33 ft swingaway ILO 33-56 ft	-687	-312	-972	-441	285	129
<b>Sub:</b> 60 ton (55 mt) 5-sheave block (stowed in trough)	450	204	643	292	-193	-88
<b>Sub:</b> 50 ton (45 mt) 3-sheave block (stowed in trough)	200	91	286	130	-86	-39
<b>Remove:</b> 8.3 ton (7.5 mt) headache ball (at front bumper)	371	168	570	259	-199	-90
<b>Remove:</b> 40 ton (35 mt) block stowed in trough)	-800	-363	-1,142	-530	342	155
<b>Remove:</b> 33 - 56 ft Bi-fold swingaway	-2,587	-1,173	-2,470	-1,120	-117	-53
<b>Remove:</b> aux hoist w/rope	-600	-272	246	112	-846	-384
<b>Remove:</b> aux boom nose	-130	-59	-251	-114	121	55

THIS CHART IS ONLY A GUIDE AND SHOULD NOT BE USED TO OPERATE THE CRANE. The individual crane's load chart, operating instructions and other instructional plates must be read and understood prior to operating the crane.



## **TMS745E** Features and Benefits

Constant improvement and engineering progress make it necessary that we reserve the right to make specification, equipment, and price changes without notice. Illustrations shown may include optional equipment and accessories and may not include all standard equipment.

GROVE® and GROVE LOGO are registered trademarks of GROVE in the U.S. and/or other countries.  
Copyright© 2000 GROVE. All rights reserved.

### **Grove Worldwide - World Headquarters**

1565 Buchanan Trail East

P.O. Box 21

Shady Grove, Pennsylvania 17256-0021, U.S.A.

Tel: (717) 597-8121

Fax: (717) 597-4062

**[www.grovetworldwide.com](http://www.grovetworldwide.com)**